



802.11AH PRODUCT PORTFOLIO

WI-FI HALOW PRODUCTS

2024/05

FOREWORD



Welcome to the inaugural edition of the Wi-Fi HaLow Product Portfolio, a compilation of cutting-edge 802.11ah products from distinguished manufacturers in Taiwan and Japan. This portfolio offers a glimpse into the Wi-Fi HaLow ecosystem, an emerging IoT connectivity market.

Wi-Fi HaLow, or 802.11ah, operates in the sub-1 GHz spectrum, providing several key advantages over traditional Wi-Fi technologies. These include an extended range of over one kilometer, lower power consumption, and enhanced penetration through walls and obstacles, making it ideal for a wide array of applications such as smart agriculture, smart cities, and healthcare.

Considering the relative lack of information about Wi-Fi HaLow products, we have compiled this portfolio to pave the way. It is a collaborative effort between CIAT (Cloud Computing and IoT Association in Taiwan) and AHPC (802.11ah Promotion Council) in Japan.

This edition is just the beginning. We look forward to including new products, updated specifications, and insights into the latest technological developments in future editions. Join us on this journey into the next generation of wireless connectivity.

Contents

Chipsets 1

Morse Micro	2
Newracom	4

Modules 6

AcSip	7
ALFA	9
AsiaRF	11
AzureWave	12
MegaChips	16
Silex	20
Vizmonet	21

Contents

Devices - Peripherals **22**

ASKEY	23
UConnet	25

Devices - AP **27**

ALFA	28
AsiaRF	36
ASKEY	42
CONTEC	44
D-Link	46
Edgecore	48
FURUNO Systems	50
Silex	52
Vantron	56

Hyper Devices **60**

TECHWARE	61
----------	----

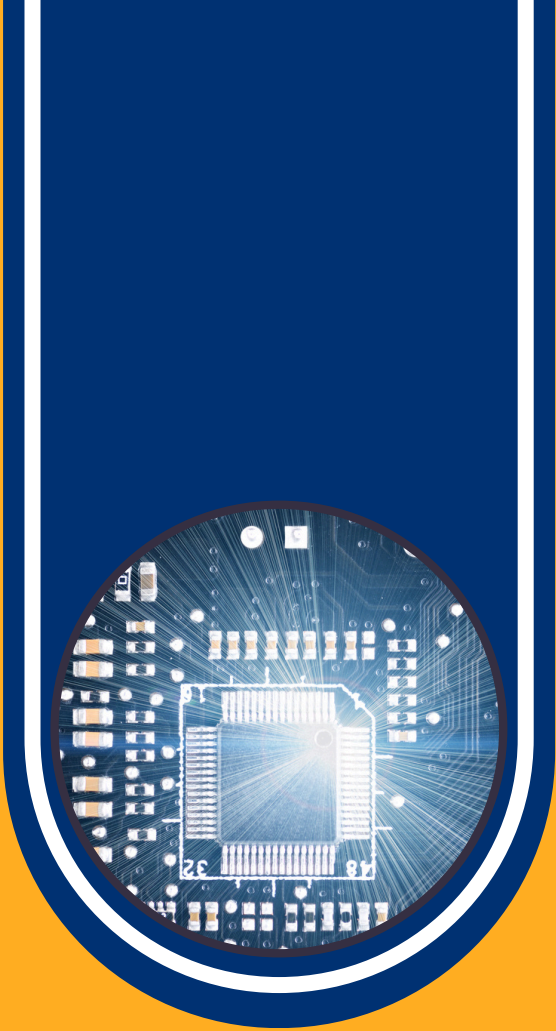

CHIPSETS

Morse Micro

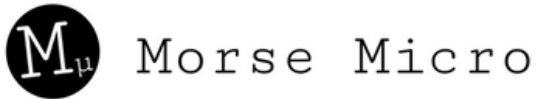
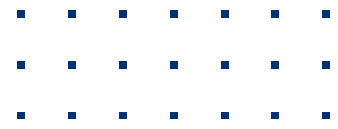

The Morse Micro team includes original inventors of Wi-Fi and designers of Wi-Fi chips that have shipped inside many billions of devices. The company is an avid contributor to the efforts of the Wi-Fi Alliance to bring interoperability certifications for Wi-Fi HaLow technology to market. Morse Micro-powered solutions empower smart homes, smart cities, infrastructure, industrial and enterprise applications, providing 10 times the range, 100 times the area, and 1000 times the volume to overcome the limitations of traditional Wi-Fi.



MM6108 SoC

The MM6108 System on Chip (SoC) is a single-chip solution providing complete Wi-Fi HaLow® connectivity through Radio, PHY, and MAC sections. Designed in accordance with the IEEE 802.11ah standard, the SoC supports data rates up to 32.5 Mbps, and provides programmable operation in the sub-1 GHz range (license exempt from RF bands worldwide). The RF interface for the MM6108 includes the option to use either the on-chip amplification for typical low-power, low-cost devices, or in conjunction with an external PCB-mount power amplifier (PA) or Front-End Module (FEM) for ultra-long-reach applications.

The RF receiver features a high linearity LNA, making the use of external filters unnecessary in many applications. Battery-operated applications are supported by a combination of features in the MM6108. The IEEE 802.11ah standard provides for extended sleep times of battery-operated STA client devices, with longer durations than other prior IEEE802.11a/b/g/n/ac generations. Several SKUs add a robust and independent Host Applications Processor (HAP) based on a low power 32b RISC-V core. Morse Micro customers can migrate their operational code to run on the HAP for the most highly-integrated SOC solution to minimize PCB size and costs for Wi-Fi HaLow® applications.

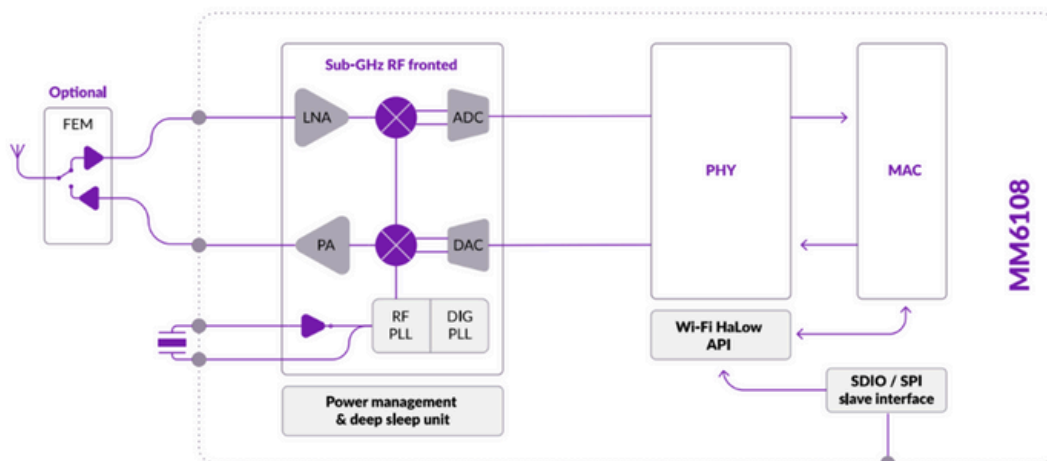

Frequency

850-950MHz

Certification Status

certified in US/Japan/EU/Canada/Taiwan (partner products)

Expected Testing Date

NA

Morse Micro

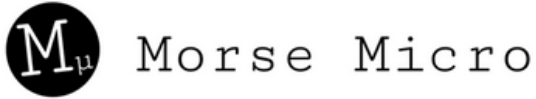
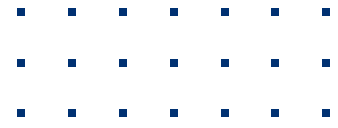

MM6108 SoC



Scenarios

For Internet of Things (IoT) and Machine-to-Machine (M2M) applications:



- ✔ Surveillance cameras and sensors
- ✔ Cloud connectivity
- ✔ Building automation systems (BAS)
- ✔ Machine performance monitors and sensors
- ✔ Building access control & security
- ✔ Drone video and navigation communications
- ✔ Rural internet access
- ✔ Utility smart meter and intelligent grids
- ✔ Industrial automation controls
- ✔ Smart home automation
- ✔ Wi-Fi HaLow® access points and bridges
- ✔ Wi-Fi HaLow® client adapters/dongles
- ✔ Smart city networks

Cases

USE CASES

Video connectivity

- Ultra-low power consumption
- >100x area coverage
- 8-MHz bandwidth suitable for HD video
- Better penetration through walls

USE CASES

Home automation

- Indoor & outdoor reach from a single AP
- Better penetration through walls & obstacles
- No dependency on Wi-Fi mesh
- IPv6 ready & WPA3 secure

USE CASES

Warehouse automation

- Whole building coverage with single AP
- Outdoor reach for yard connectivity
- WPA3 secure & IPv6 ready
- Address up to 8,191 STAs per AP

Example applications of Wi-Fi HaLow

Rural connectivity

- Extensive coverage with single AP
- Backhaul network for other IoT
- Reliable data connectivity
- Suitable for long-range, low data rate connectivity



bob.sato@morsemicro.com



www.morsemicro.com

NEWRACOM

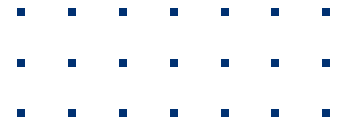

Newracom is the world's leading fabless semiconductor company for Wi-Fi HaLow. We are partnered with numerous world leading semiconductor companies, consumer electronic device manufactures, and IoT/ M2M device manufactures to provide innovative Wi-Fi HaLow connectivity by customizing WLAN functionalities into business systems for high profitability while being cost effective.



NRC7394 SoC

NRC7394 is the advanced Wi-Fi HaLow System-on-Chip (SoC), designed specifically to meet the connectivity needs of the Internet of Things (IoT) era. With its exceptional range, low power consumption, and seamless integration capabilities, NRC7394 is the ideal solution for enabling a wide range of IoT applications. Its capability to connect up to 8K devices within a single network makes it perfect for environments with dense deployments of IoT devices. Moreover, Wi-Fi HaLow incorporates advanced power-saving features, significantly reducing power consumption and greatly extending the battery life of connected devices.

With fully integrated power amplifiers, the NRC7394 offers a robust output of up to 17dBm, providing sufficient power for a wide range of IoT applications. Moreover, its compatibility with various commercial external FEM devices enables further flexibility to achieve even higher output power levels.

The NRC7394's standalone mode support enables the execution of a wide range of IoT applications on embedded ARM Cortex-M3. Additionally, the availability of numerous sample applications simplifies the development of new IoT application programs.

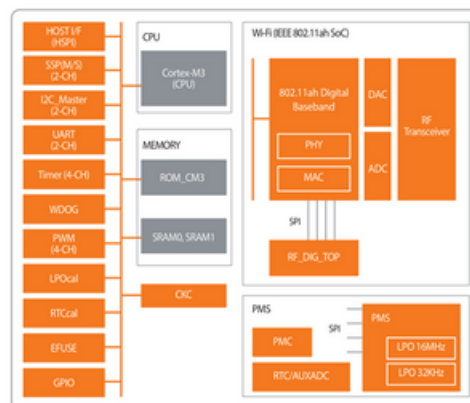

Frequency

750-950MHz

Certification Status

certified in USA/Japan/EU/Singapore/Korea (Customer product solutions)

Expected Testing Date

NA

NEWRACOM

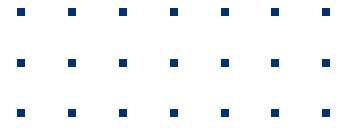

NRC7394 SoC



Scenarios



TARGET IOT APPLICATIONS

- ✔ Smart home
- ✔ Smart grid
- ✔ Security and access control
- ✔ Healthcare
- ✔ Wearable
- ✔ Agriculture
- ✔ Building automation
- ✔ Industrial automation
- ✔ Drones and robotics
- ✔ Smart cities

Cases

<p>Smart Building Automation In Asia and Europe</p>	<p>Robotic Logistic Automation In China and North America</p>	<p>Smart Automated Retailer in North America and Europe</p>	<p>Rescue and Emergency Network in US, Asia and Europe</p>



frank.lin@newracom.com



www.newracom.com

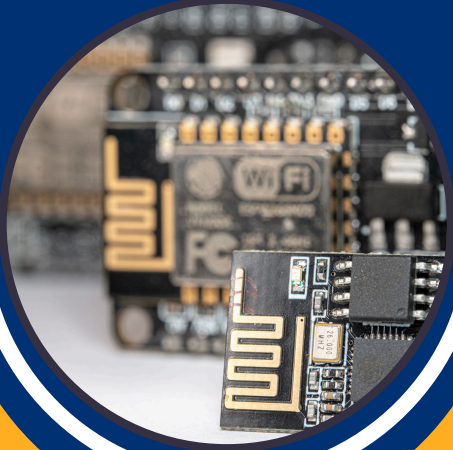

MODULES

AcSip Technology

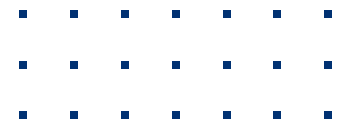

AcSiP, as the name literally implies, we focus on developing “Advanced Communication System in Package” technologies and services. Since 2009, we have accumulated lots of experience in wireless communication & various applications. With the knowledge & valuable experience, we are able to provide series of wireless connectivity solutions. Our products line include LoRa, Bluetooth, NFC, Zigbee, WiFi 4/6/6E, GPS, and even the new long range communication standard – WiFi HaLow.



AI7394L/LT

AI7394L/LT is a highly integrated SoC incorporating baseband (MAC & PHY), Sub 1 GHz radio transceiver, and ADC/DAC in a single module. It is fully compliant with the IEEE 802.11ah standard which is the long-range and low-power version of Wi-Fi standard. It supports 1/2/4 MHz channel bandwidth which yields 150 Kbps to 15 Mbps PHY rate that can handle low-rate sensors to high-rate surveillance camera applications. The self-contained Wi-Fi networking with huge range of data throughput offers the ideal solution to add Wi-Fi connectivity to IoT products.

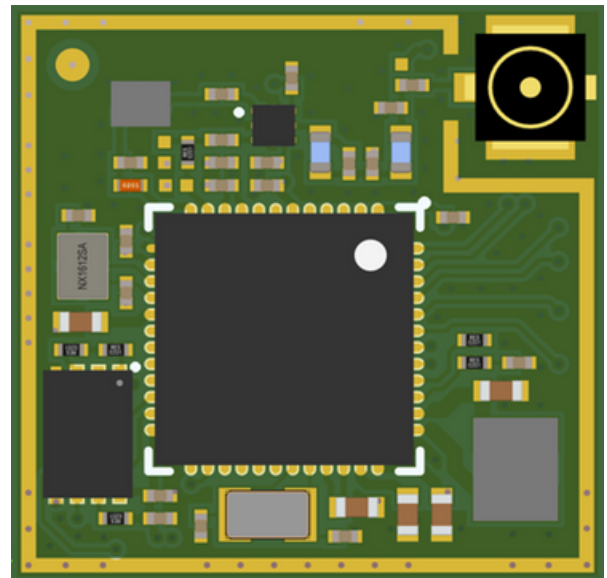

Frequency

WiFi Halow

Certification Status

certified in FCC / CE / TELEC

Expected Testing Date

2024 Q3

AcSip Technology

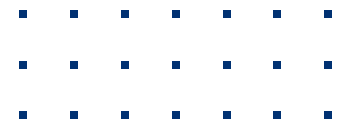

Logistic Tag



Scenarios

Most logistics labels are still paper-based and not reusable. Using e-paper logistics labels can address the issue of non-reusability in logistics labels.

By integrating with other sensors, real-time information on the item's location, trajectory, temperature, whether it has fallen, and one-click receipt/return can be obtained.

From 2030, the EU regulations mandate that all cardboard boxes must be reusable. Many businesses are making adjustments in terms of material improvements and business models to comply with these changes.

Cases

The integration of built-in WiFi HaLow technology into logistics labels brings revolutionary advantages to supply chain management. This technology ensures reliable connectivity even in challenging environments, enabling real-time, accurate data transmission for logistics managers to constantly monitor the whereabouts and conditions of shipments.

WiFi HaLow Logistic Tag technology underscores a commitment to sustainability by reducing the reliance on traditional, resource-intensive tracking methods. By leveraging wireless communication and eliminating the need for disposable tracking devices, businesses can significantly reduce their environmental footprint while simultaneously cutting costs associated with maintenance and disposal.

Overall, this technology will help businesses stand out in the fiercely competitive global market, achieving higher levels of supply chain management excellence.



jacky@acsip.com.tw



www.acsip.com.tw

ALFA NETWORK Inc.

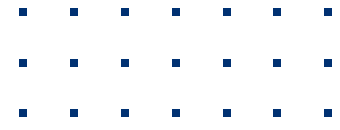

ALFA Network Inc. is dedicated to providing customized networking, connectivity and IoT solutions that cater to each customer’s unique needs through our specialized OEM/ODM services. We ensure that all our products meet the highest quality standards, from innovative design to engineering testing. Our comprehensive approach guarantees the delivery of reliable and up-to-date products.



AHST7394S

AHST7394S is world's leading WiFi HaLow™ solder down module

- Newracom NRC7394 inside
- Up to 15Mbps data rate
- Supports AP and STA mode
- HaLow IPEX/U.FL antenna connector
- SPI and UART support for host interface



Frequency

US(902 MHz–928 MHz)
EU(863 MHz–868 MHz)
JP(920.5–927.5 MHz)

Certification Status

certified in FCC / CE

Expected Testing Date

2024 08

ALFA NETWORK Inc.

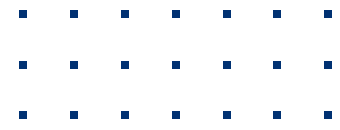

AHST7394S

Scenarios



The AHST7394S allows building long range, ultra-low power WiFi networks in sub 1 GHz license-exempt bands, utilizing compact form factor, save space on your motherboard, the various applications of IoT are up to you.

The AHST7394S data rate up to 15 Mbps which better than LoRa 38.4 Kbps with the high-speed data rate, it enables connectivity for many IoT applications, including sensors, weather stations, industrial monitoring, medical patient monitoring, agriculture monitoring, surveillance camera, EV car chargers, vehicle-to-vehicle and vehicle-to-infrastructure communications, commercial drone

Cases

EV charging station

Each charging station will deploy many charging piles. WiFi HaLow technology can be used to improve communication distance and security. With higher data throughput, it can provide multimedia value-added services, bring new experiences and realize new business models.

Commercial drone

Commercial UAV guidance and control frequencies are mostly in the general 2.4GHz and 5.8GHz frequency bands. Now the WiFi HaLow in the 900MHz frequency band is used, which can bring the advantages of long transmission distance and low power consumption. Whether in commerce, agriculture, industry, transportation It has good applications in fields such as disaster prevention and disaster relief.



sales@alfa.com.tw



www.alfa.com.tw

AsiaRF Co., Ltd.

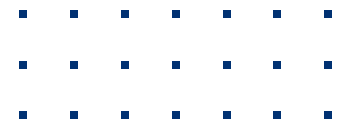

AsiaRF, founded in Taipei in 1997, is a global leader in wireless connectivity solutions, trusted especially in North America. We offer Wi-Fi HaLow™, Wi-Fi 7, Wi-Fi 6E, Wi-Fi 6, 5G, BLE, LoRa WAN, and more. Committed to quality and service, we collaborate with Taiwanese distributors to stay competitive.



Wi-Fi HaLow Module MM610X

Wi-Fi HaLow module Sub-GHz, MM610X-001 is based on MorseMicro MM6108 RF SOC and obtained multi-national regulations. Wi-Fi HaLow is a low-power, long-range version of the IEEE 802.11ah standard, designed for IoT applications.



Frequency	Certification Status	Expected Testing Date
850MHz-950MHz	certified in Taiwan	2024 10

AzureWave

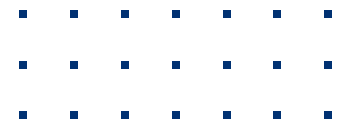

AzureWave has always been striving to realize its infinite potential of innovation in all aspects, better quality and more reliable delivery in its journey to become one of the most specialized module experts in the industry.



AW-HM610

AW-HM610 is the smallest IEEE 802.11ah Wi-Fi module that operates in the Sub 1GHz license-exempt band, offering longer range and higher data rate for internet of things (IoT) applications.

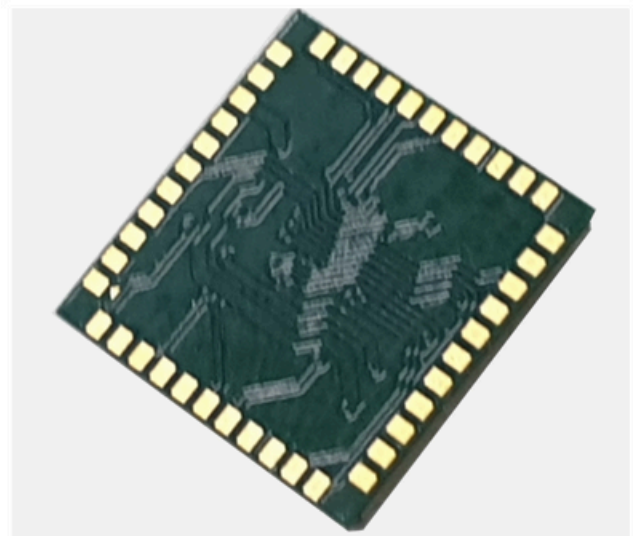

Frequency

US: 902~928 MHz
JP: 920~928 MHz

Certification Status

certified in US/JP

Expected Testing Date

2024 06

AzureWave

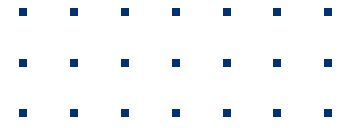

AW-HM610



Scenarios

AW-HM610 supports 1/2/4 MHz channel bandwidth which yields 150 Kbps to 15 Mbps PHY rate that can handle low-rate sensors to high-rate surveillance camera applications. The self-contained Wi-Fi networking with huge range of data throughput offers the ideal solution to add Wi-Fi connectivity to IoT products with low power consumption requirements.

Cases

WiFi HaLow is combined with IP CAM and sensor, and can be used for long-distance image recognition and sensing functions, such as parking monitoring, license plate sensing, smart factories, and vehicle charging equipment, etc.

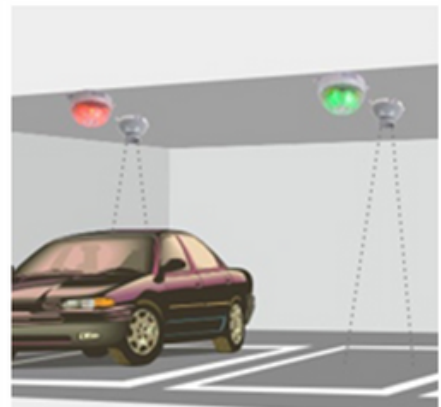

AzureWave

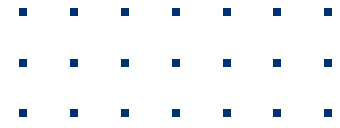

AzureWave has always been striving to realize its infinite potential of innovation in all aspects, better quality and more reliable delivery in its journey to become one of the most specialized module experts in the industry.



AW-HM662

AW-HM662 is the Higher Power IEEE 802.11ah Wi-Fi module that operates in the Sub 1GHz license-exempt band, offering longer range and higher data rate for internet of things (IoT) applications.

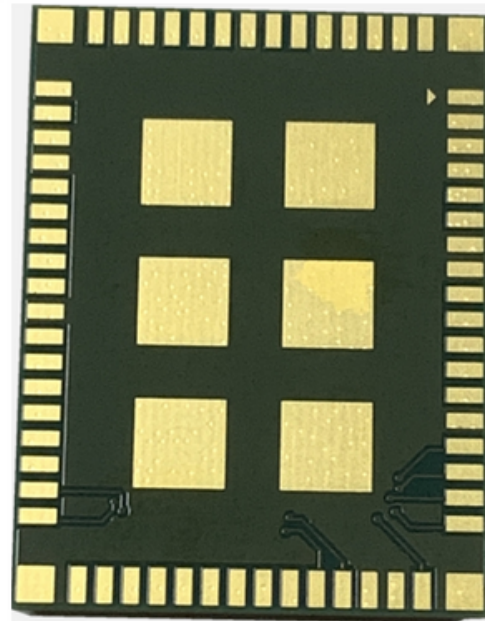

<u>Frequency</u>	<u>Certification Status</u>	<u>Expected Testing Date</u>
US: 902~928 MHz	certified in US	2024 12

AzureWave

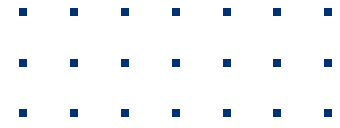

AW-HM662



Scenarios

AW-HM662 provide the higher power 802.11ah solution, and that supports 1/2/4 MHz channel bandwidth which yields 150 Kbps to 15 Mbps PHY rate that can handle low-rate sensors to high-rate surveillance camera applications. The self-contained Wi-Fi networking with huge range of data throughput offers the ideal solution to add Wi-Fi connectivity to IoT products requirements.

Cases

WiFi HaLow is combined with IP CAM and sensor, and can be used for long-distance image recognition and sensing functions, such as parking monitoring, license plate sensing, smart factories, and vehicle charging equipment, etc.

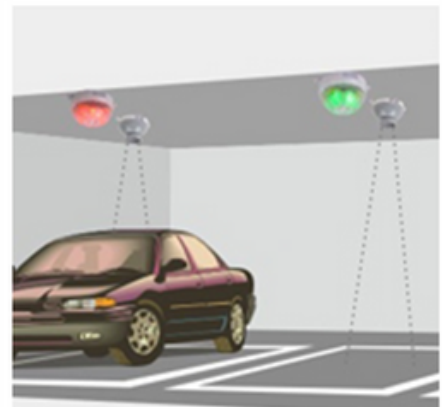

MegaChips Corporation

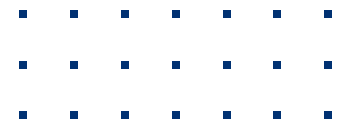

MegaChips



MegaChips was founded on 1990 as Japan's first fabless semiconductor manufacturer to provide solutions of innovative system LSI. We provide ASIC, ASSP, and modules worldwide to support the business success of our customers with creative technology and innovative solutions in growth fields such as industrial equipment, communication infrastructure and FA.



Wi-Fi HaLow™ RF module

- 1. Multi-functional module works as an access point or an end point
- 2. Simplified features for less footprint and cost
- 3. Host interface : SDIO, SPI
- 4. An expansion board for development works with Raspberry Pi and other host systems is available

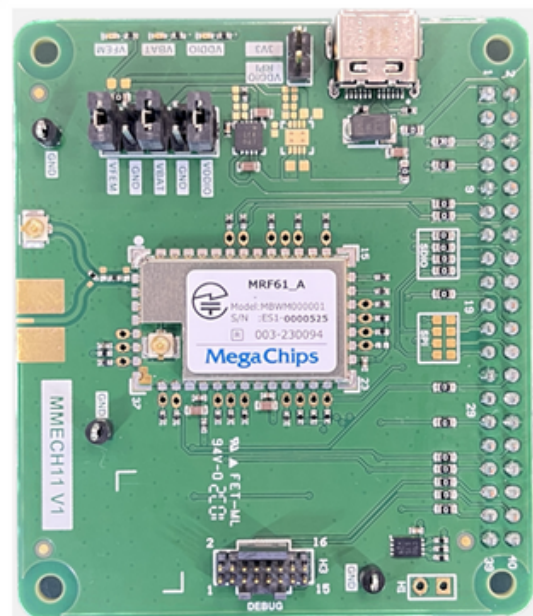
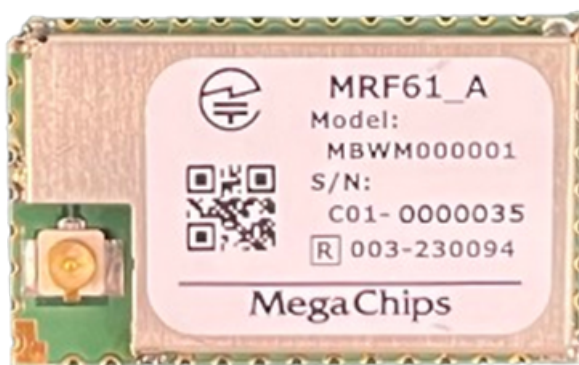

Frequency

IEEE802.11ah
TELEC – 923 ~ 927 MHz
FCC, ISED – 902 ~ 928MHz

Certification Status

certified in TELEC/FCC/ISED

Expected Testing Date

2024 04/05

MegaChips Corporation

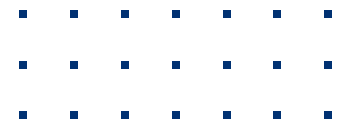

MegaChips



Wi-Fi HaLow™
RF module

Scenarios

Image for Wi-Fi HaLow™ access point's board



RJ-45



Microcontroller

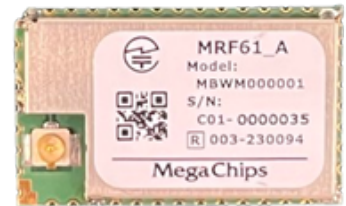

Wi-Fi HaLow™
RF module

Cases

- 1. Access Point
- 2. EV charge station
- 3. Construction equipment
- 4. Surveillance camera
- 5. Smart home network



AccessPoint



Construction Equipment



Video Intercom

MegaChips Corporation

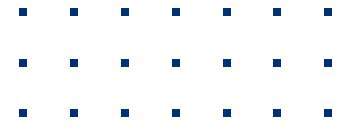

MegaChips



MegaChips was founded on 1990 as Japan's first fabless semiconductor manufacturer to provide solutions of innovative system LSI. We provide ASIC, ASSP, and modules worldwide to support the business success of our customers with creative technology and innovative solutions in growth fields such as industrial equipment, communication infrastructure and FA.



Wi-Fi HaLow™ RF+MCU module

1. Designed for an end point application such as sensors.
2. All necessary building block are on-board to develop.
3. OS support : Amazon Free RTOS
4. Optional secure element IC for highly secure communication to the cloud.
5. Interface : SDIO, SPI, I2C, I2S, UART, GPIO, ADC, DAC, PWM, COUNTER, TCC, USB2.0
6. A development board for MCU module with USB device interface, debug interface (SWD, UART), and mikroBUS™ for easy debugger / sensor connection is available

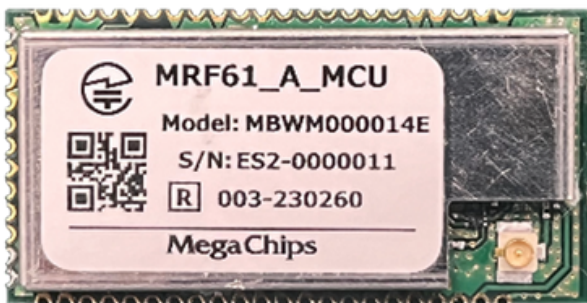

Frequency

IEEE802.11ah
TELEC - 923 ~ 927 MHz
FCC, ISED - 902 ~ 928MHz

Certification Status

certified in TELEC/FCC/ISED

Expected Testing Date

2024 04/07

MegaChips Corporation

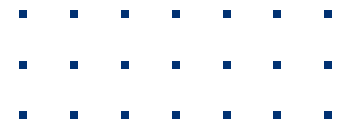

MegaChips



**Wi-Fi HaLow™
RF + MCU module**

Scenarios

Image for Wi-Fi HaLow™ sensor board

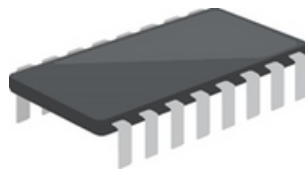

**Wi-Fi HaLow™
RF + MCU module**

Power IC

Various Sensors

Cases

- 1.Factory: Sensor network
- 2.Warehouse: Pallet and vehicle management
- 3.Agriculture: Crop Management
- 4.Drone: Image data transmission
- 5.Walkie-talkie: Voice data transmission



Sensor Devices



Drones



Walkie-Talkies

Silex technology, Inc.

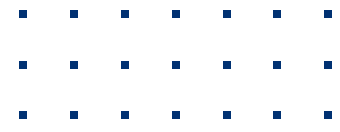

Through wireless expertise, unrivaled quality, and dedicated support, Silex Technology delivers highly reliable and secure wireless connectivity products for medical, industrial, and commercial customers. We are dedicated to providing a single-vendor solution for hardware and software support from design through manufacturing, which results in a completely connected, always-on experience.



SX-SDMAH(JP)

SX-SDMAH is an 802.11ah Wi-Fi HaLow SDIO/SPI module enabled by Morse Micro's MM6108. It features a host SDIO or SPI interface to operate with a processor or a microcontroller. Its small footprint design with the integrated antenna connector saves the PCB space and allows a more flexible embedded system design. The SX-SDMAH has been already certified to enable the embedded products for Japanese market.

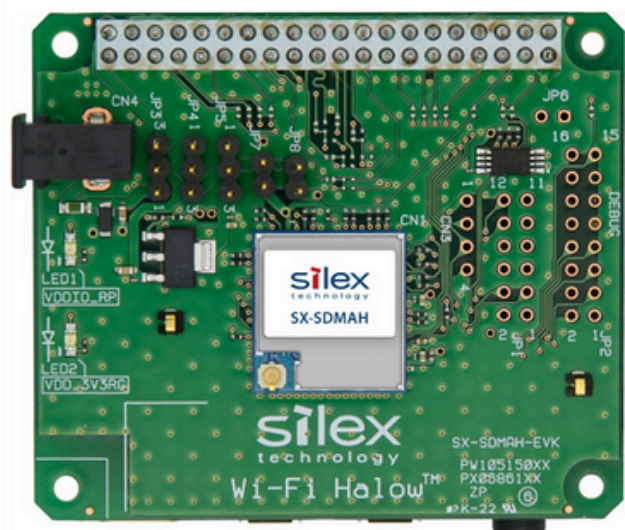

Frequency

920.5-928.1MHz

Certification Status

certified in Japan

Expected Testing Date

NA

Vizmonet Pte Ltd

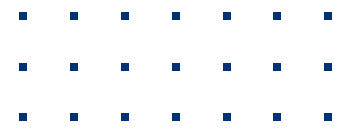

Vizmonet is a Singapore based company founded in 2011 with a prime focus on the design and manufacture of Carrier-Class-Customized™ Wireless Connectivity Solutions. Our Built-to-Customize™ wireless solutions in the form of modules and complete systems drive a variety of applications that have been deployed globally by our OEM customers across various industry verticals. For more than a decade, Vizmonet’s Core RF design and manufacturing expertise has helped many OEMS to anchor a niche position in the wireless ecosystem.



ahSP1

This high performance module, works as a companion with SONY SPRESENCE main board by providing Wi-Fi HaLow connectivity to unlock numerous Industrial IOT application scenarios.

ahSP1 has already obtained Japan Type Approval certification and is ready to be deployed in Japan Market.

Operating in the license free band 902 MHz to 928 MHz, it supports bandwidth profiles of 1/2/4 MHz and industrial grade operating temperature -40 deg C to +85 deg C

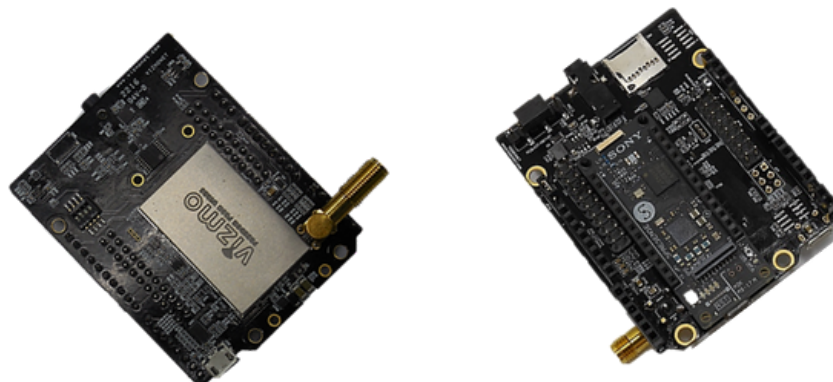

Scenarios

Agriculture tech, Industrial IoT, Industrial connectivity, Sound diagnostics, Real-time sensor analysis

Frequency

920-928MHz

Certification Status

certified in Japan

Expected Testing Date

already certified



DEVICES PERIPHERALS

ASKEY Computer Corp.

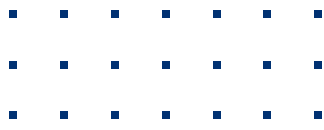

Established in 1989, Askey Computer Corp. is a member of ASUSTeK Computer Inc., specializing in development of network communications and electronics manufacturing. With nearly 6,000 staff, Askey is headquartered in New Taipei City, Taiwan. Equipped with advanced manufacturing sites both at domestic and abroad. Askey now has R&D and business strongholds in Taiwan, China, Brazil, Japan, America and more.



CAM2301

Askey Wi-Fi HaLow IP camera, CAM2301, utilizes 802.11ah (Wi-Fi HaLow) technology to provide lower power consumption, wider coverage range and better transmission throughput video streams.

The key features:

- 3x Optical Zoom or Fixed Lens, 2MP SONY CMOS sensor, Full HD video resolution
- 20M IR for night modes, Human detection by edge AI
- RS-485 for external sensor control
- 802.11b/g/n,10/100M PoE

It is easy to integrate into various smart home and IoT systems, and supports multiple devices to connect simultaneously. Askey 11ah IP camera is an ideal choice for environments with security requirements



Frequency

Wi-Fi
 US 2.4GHz (2412MHz ~ 2472MHz)
 JP 2.4GHz (2412MHz~2462MHz)
11ah
 US 902~928MHz
 JP 921-927MHz

Certification Status

certified in Japan

Expected Testing Date

completed

ASKEY Computer Corp.

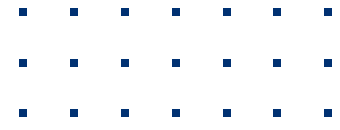

CAM2301

Scenarios

CAM2301 has human detection feature and IR cut filter and can connect with environmental sensor by RS485 interface. It can monitor security in very dark situation and make sure environment safety in advance. It is very suitable for wide and open space as factory, warehouse, farm field and rural area.

Cases

In Japan, we setup a camera nearby the river to monitor water level. CAM2301 captures the picture and uploads it to management system periodically. User doesn't need to go to places but can check the status at the same time.



UConnect International Co., Ltd.

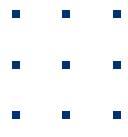

Uconnect was founded on 2004 and is major in the communications and information technology. We supply the wireless and embedded system products for Internet of Things applications. We supply the OEM/ODM service.



Dual band WiFi Serial converter

- 1.2.4 GHz Wi-Fi 6 (802.11 ax)
- 2.IEEE 802.11 ah: 850~925 MHz
- 3.Serial Port: RS-232, RS-422/485
- 4.Webpage configuration
- 5.TCP Server/Client, UDP Server/Client, Http Client, Https Client, Cloud



Frequency

915 MHz & 2.4GHz

Certification Status

certified in CE/FCC/TELEC/RoHS

Expected Testing Date

2024 05

UConnect International Co., Ltd.

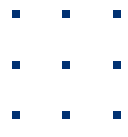

Dual band WiFi Serial converter

Scenarios

The dualband WiFi support the AP or STA mode for both WiFi 6 or AH. The adapter will converter the Wifi AH to general Router to extend the range.



Cases

- 1.CNC machine G-code bi-directional data transmission in factory
- 2.RTLS system for indoor tracking applications
- 3.Access control system for RFID data transmission
- 4.Data collection in Hospital
- 5.Wireless sensor network for medical supplies
- 6.Rack inventory system in data center

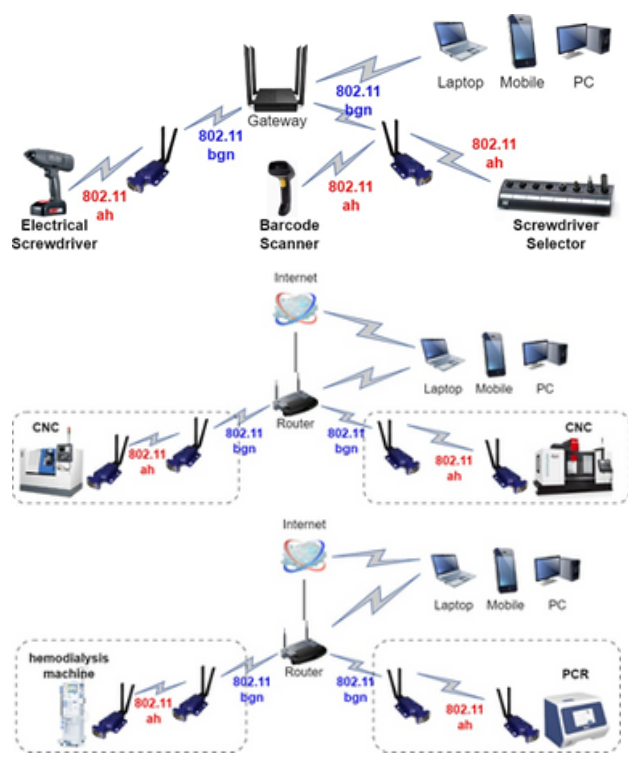



DEVICES AP

ALFA NETWORK Inc.

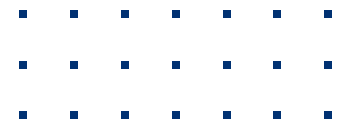

ALFA Network Inc. is dedicated to providing customized networking, connectivity and IoT solutions that cater to each customer’s unique needs through our specialized OEM/ODM services. We ensure that all our products meet the highest quality standards, from innovative design to engineering testing. Our comprehensive approach guarantees the delivery of reliable and up-to-date products.



HaLow-U

HaLow-U is the world's first USB Type-C WiFiHaLow™ AP/CPE

- AP/Station/Mesh three modes in one
- Newracom NRC7292 inside
- Detachable SMA external antenna
- USB Type-C for power and data
- Plug-and-play, desktop computers and laptops can be instantly upgraded to WiFiHaLow



Frequency

US(902 MHz–928 MHz)
EU(863 MHz–868 MHz)
JP(920.5–927.5 MHz)

Certification Status

certified in FCC / CE

Expected Testing Date

certification completed

ALFA NETWORK Inc.

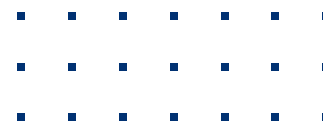

HaLow-U

Scenarios



The HaLow-U USB adapter allows building long range, ultra-low power WiFi networks in sub 1 GHz license-exempt bands, leverage the ubiquitous, plug-and-play USB Type-C interface, getting started with this new WiFi standard is straightforward.

With powerful ARM™ Cortex-A7 based SOC and Newracom advanced WiFi HaLow™ SoC, up to 15 Mbps data throughput.

It enables connectivity for many IoT applications, including sensors, weather stations, industrial monitoring, medical patient monitoring, agriculture monitoring, surveillance camera.

Cases

Smart city applications

Located in Medellin, a city in Colombia, South America, traffic light data and control need to be more flexible and easier to deploy. Using HaLow-U meets the city's needs.

Smart agriculture and transportation

The Netherlands, located in Europe, is a major exporter of food and agricultural products. Improving production capacity and reducing production costs are the most important issues. HaLow-U can contribute to smart agriculture and transportation.

Large-scale live broadcast camera control

A professional broadcast equipment manufacturer located in Belgium, network cabling for multiple cameras working together is always a problem. HaLow-U solves this problem by providing long-distance and reliable WiFi.



sales@alfa.com.tw



www.alfa.com.tw

ALFA NETWORK Inc.

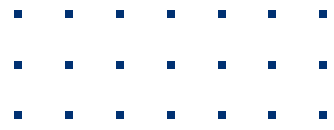

ALFA Network Inc. is dedicated to providing customized networking, connectivity and IoT solutions that cater to each customer’s unique needs through our specialized OEM/ODM services. We ensure that all our products meet the highest quality standards, from innovative design to engineering testing. Our comprehensive approach guarantees the delivery of reliable and up-to-date products.

HaLow-R



HaLow-R is the world's leading WiFi HaLow™ + WiFi 4 Indoor IoT Router

- Router/Extender two modes in one
- Morse Micro MM6108 inside
- WiFi HaLow™ data rate up to 32.5 Mbps @ 8MHz BW
- WiFi 4 data rate up to 300 Mbps @ 40MHz BW
- WiFi HaLow™ support AP/Station mode
- RJ45 Fast Ethernet support
- Detachable dipole antenna



Frequency

US(902 MHz–928 MHz)
EU(863 MHz–868 MHz)
JP(920.5–927.5 MHz)

Certification Status

certified in FCC / CE

Expected Testing Date

2024 Q3

ALFA NETWORK Inc.

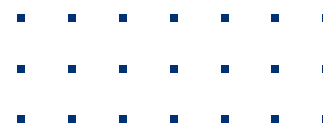

HaLow-R



Home automation

- Indoor & outdoor reach from a single AP
- Better penetration through walls & obstacles
- No dependency on Wi-Fi mesh
- IPv6 ready & WPA3 secure



Building automation

- Whole building coverage
- Simplified infrastructure
- Better penetration through walls & floors
- WPA3 secure & IPv6 ready

Scenarios

The HaLow-R indoor IoT series allows building long range, ultra-low power WiFi networks in sub 1 GHz license-exempt bands, along with popular WiFi2.4 GHz to share Internet connection to a laptop, tablet and smart phone, getting started with this new WiFi standard is straightforward.

With high performance MediaTek router chip and Morse Micro advanced WiFi HaLow™ SoC, up to 32.5 Mbps data throughput.

It enables connectivity for many IoT applications, including sensors, weather stations, industrial monitoring, medical patient monitoring, agriculture monitoring, surveillance camera, smart building, smart home.

Cases

Smart Home and Smart Building

The number of connected devices in smart homes continues to increase. Wi-Fi HaLow uses the Sub-GHz frequency band, which not only enhances the penetration and coverage of Wi-Fi signals, but also avoids the very crowded 2.4GHz frequency band, providing a better solution for the Internet of Things in the home. The device brings a reliable and seamless networking solution.

IoT devices are often deployed on the perimeter or outside of buildings, such as security cameras, door locks, and window sensors. These devices often require more emphasis on coverage and penetration than high transmission throughput. Wi-Fi HaLow Most Notable One of the advantages is extended coverage, allowing climate sensors and sprinkler systems deployed in garages, front or backyards, or even rooftops to easily connect to APs and smart building ecosystems.



sales@alfa.com.tw



www.alfa.com.tw

ALFA NETWORK Inc.

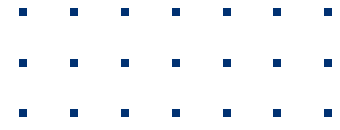

ALFA Network Inc. is dedicated to providing customized networking, connectivity and IoT solutions that cater to each customer’s unique needs through our specialized OEM/ODM services. We ensure that all our products meet the highest quality standards, from innovative design to engineering testing. Our comprehensive approach guarantees the delivery of reliable and up-to-date products.

Tube-AH



Tube-AH is the world's first WiFi HaLow™ outdoor AP/CPE with PoE

- AP/Station/Mesh three modes in one
- Newracom NRC7292 inside
- N female antenna connector
- Passive PoE support
- Mast mounted installation enclosure
- IP66 waterproof resistance



Frequency

US(902 MHz–928 MHz)
EU(863 MHz–868 MHz)
JP(920.5–927.5 MHz)

Certification Status

certified in FCC / CE

Expected Testing Date

certification completed

ALFA NETWORK Inc.

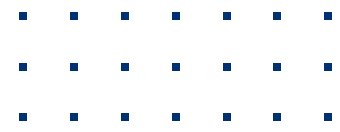

Tube-AH

Scenarios



The Tube-AH outdoor series allows building long range, ultra-low power WiFi networks in sub 1 GHz license-exempt bands, utilizing compact, mast mounted waterproof enclosure, getting started with this new WiFi standard is straightforward.

With powerful ARM™ Cortex-A7 based SOC and Newracom advanced WiFi HaLow™ SoC, up to 15 Mbps data throughput.

It enables connectivity for many IoT applications, including sensors, weather stations, industrial monitoring, medical patient monitoring, agriculture monitoring, surveillance camera.

Cases

Smart city applications

Located in Medellin, a city in Colombia, South America, traffic light data and control need to be more flexible and easier to deploy. Using Tube-AH meets the city's needs.

Smart agriculture and transportation

The Netherlands, located in Europe, is a major exporter of food and agricultural products. Improving production capacity and reducing production costs are the most important issues. Tube-AH can contribute to smart agriculture and transportation.

Large-scale live broadcast camera control

A professional broadcast equipment manufacturer located in Belgium, network cabling for multiple cameras working together is always a problem. Tube-AH solves this problem by providing long-distance and reliable WiFi.



sales@alfa.com.tw



www.alfa.com.tw

ALFA NETWORK Inc.

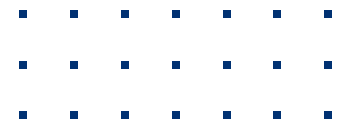

ALFA Network Inc. is dedicated to providing customized networking, connectivity and IoT solutions that cater to each customer’s unique needs through our specialized OEM/ODM services. We ensure that all our products meet the highest quality standards, from innovative design to engineering testing. Our comprehensive approach guarantees the delivery of reliable and up-to-date products.

Tube-AHM



Tube-AHM is the world's leading WiFi HaLow™ outdoor AP/CPE with PoE

- AP/Station two modes in one
- Morse Micro MM6108 inside
- Data rate up to 32.5 Mbps @ 8MHz BW
- N female antenna connector
- Passive PoE support
- Mast mounted installation enclosure
- IP66 waterproof resistance



Frequency

US(902 MHz–928 MHz)
EU(863 MHz–868 MHz)
JP(920.5–927.5 MHz)

Certification Status

certified in FCC / CE

Expected Testing Date

2024 Q3

ALFA NETWORK Inc.

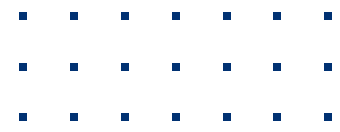

Tube-AHM



Scenarios

The Tube-AHM outdoor series allows building long range, ultra-low power WiFi networks in sub 1 GHz license-exempt bands, utilizing compact, mast mounted waterproof enclosure, getting started with this new WiFi standard is straightforward.

With high performance MediaTek router chip and Morse Micro advanced WiFi HaLow™ SoC, up to 32.5 Mbps data throughput.

It enables connectivity for many IoT applications, including sensors, weather stations, industrial monitoring, medical patient monitoring, agriculture monitoring, surveillance camera.

Cases

Smart city applications

Located in Medellin, a city in Colombia, South America, traffic light data and control need to be more flexible and easier to deploy. Using Tube-AHM meets the city's needs.

Smart agriculture and transportation

The Netherlands, located in Europe, is a major exporter of food and agricultural products. Improving production capacity and reducing production costs are the most important issues. Tube-AHM can contribute to smart agriculture and transportation.

Large-scale live broadcast camera control

A professional broadcast equipment manufacturer located in Belgium, network cabling for multiple cameras working together is always a problem. Tube-AHM solves this problem by providing long-distance and reliable WiFi HaLow.



sales@alfa.com.tw



www.alfa.com.tw

AsiaRF Co., Ltd.

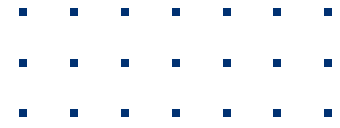

AsiaRF, founded in Taipei in 1997, is a global leader in wireless connectivity solutions, trusted especially in North America. We offer Wi-Fi HaLow™, Wi-Fi 7, Wi-Fi 6E, Wi-Fi 6, 5G, BLE, LoRa WAN, and more. Committed to quality and service, we collaborate with Taiwanese distributors to stay competitive.

Wi-Fi HaLow Mesh Gateway Dual Band
ARFHL-AP



The ARFHL-AP Wi-Fi HaLow IoT Gateway revolutionizes industrial IoT (IIoT) connectivity with its Dual-Band Wi-Fi 4 & HaLow technology. This cutting-edge device is engineered for optimal performance in various industrial environments, offering unparalleled flexibility and efficiency.

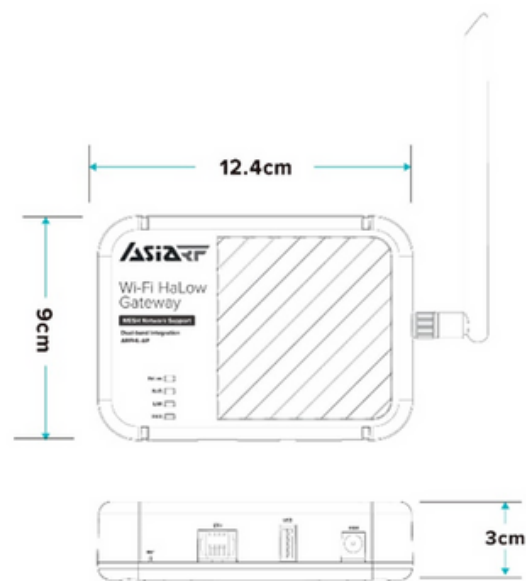

Frequency

Wi-Fi 4: 2412MHz-2462MHz
Wi-Fi HaLow: 923MHz-927MHz

Certification Status

certified in Taiwan

Expected Testing Date

2024 05

AsiaRF Co., Ltd.

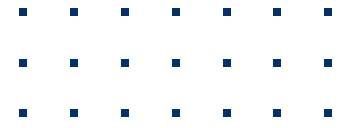

Wi-Fi HaLow Mesh Gateway Dual Band
ARFHL-AP



Scenarios

Energy Remote Sensor/Control Solution

Real-time monitoring allows users to track energy consumption patterns and make informed decisions for efficient energy management. Remote control capabilities enable users to adjust energy systems in real-time, optimizing energy usage and reducing waste. The solution offers reliability and scalability, ensuring seamless performance and adaptability to various energy management needs and systems.

Cases

Our customer uses AsiaRF's HaLow gateway product in Taiwan's official smart meters to collect information and real-time monitoring energy consumption patterns.



sales@asiarf.com



<https://www.asiarf.com>

AsiaRF Co., Ltd.

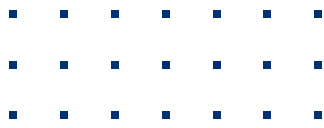

Wi-Fi HaLow Mesh Gateway Dual Band
ARFHL-AP



Scenarios

Rural Internet Enhancement Solution

In today's digital age, reliable internet connectivity is crucial for economic development, education, healthcare, and social inclusion. However, rural areas often face significant challenges in accessing high-quality internet services. The Rural Internet Enhancement Solution, powered by Wi-Fi HaLow™ technology, is a game-changer in bridging the digital divide and empowering rural communities with enhanced wireless connectivity.

Cases

In Africa, many rural areas lack reliable internet due to sparse populations and inadequate infrastructure. A solution combining Wi-Fi HaLow™ technology with low Earth orbit satellites has been developed to provide robust internet coverage. Wi-Fi HaLow™ offers long-range, low-power connectivity, ideal for vast rural areas, while satellites ensure global reach, even to remote locations. This integrated approach has significantly improved internet access in rural African communities, supporting local education, healthcare, and economic growth, and providing a scalable model to bridge the digital divide globally.



AsiaRF Co., Ltd.

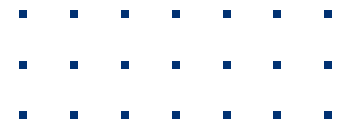

Wi-Fi HaLow Mesh Gateway Dual Band
ARFHL-AP



Scenarios

Factory Automation by Wi-Fi HaLow

Transforming Industrial Efficiency and Connectivity Wi-Fi HaLow™ is revolutionizing factory automation by offering enhanced connectivity, real-time monitoring and control, efficient asset management, and scalability. By leveraging Wi-Fi HaLow™ technology, industrial operations can achieve seamless communication, optimize production processes, and improve overall efficiency. The ability to establish reliable connections over long distances, combined with real-time data exchange, empowers manufacturers to make informed decisions, enhance productivity, and minimize downtime. As factory automation continues to evolve, Wi-Fi HaLow™ stands as a key enabler, unlocking new possibilities for increased efficiency, reduced costs, and improved competitiveness in the industrial sector.

Cases

Wi-Fi HaLow™ is revolutionizing logistics warehouse automation by leveraging its MESH networking capabilities to ensure comprehensive connectivity across expansive facilities. This advanced system enables seamless real-time tracking of goods, automatic inventory updates, and efficient order processing, significantly reducing human errors and boosting customer satisfaction. By facilitating predictive maintenance, Wi-Fi HaLow™ helps minimize equipment failures and downtime, enhancing operational reliability. The implementation of this technology in warehouses not only streamlines operations but also leads to considerable cost savings and a stronger competitive edge, demonstrating the significant advantages of Wi-Fi HaLow™ in modern logistics environments.



sales@asiarf.com



<https://www.asiarf.com>

AsiaRF Co., Ltd.

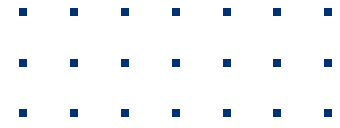

AsiaRF, founded in Taipei in 1997, is a global leader in wireless connectivity solutions, trusted especially in North America. We offer Wi-Fi HaLow™, Wi-Fi 7, Wi-Fi 6E, Wi-Fi 6, 5G, BLE, LoRa WAN, and more. Committed to quality and service, we collaborate with Taiwanese distributors to stay competitive.

**Wi-Fi HaLow Mesh
Portable Gateway
ARFHL-UM**



Wi-Fi HaLow MESH portable gateway ARFHL-UM dual-band, offering plug-and-play, zero-configuration connectivity with exceptional energy efficiency and USB power bank support. It provides long-range, seamless mobile networking over distances exceeding 1 km, ideal for on-the-go applications.

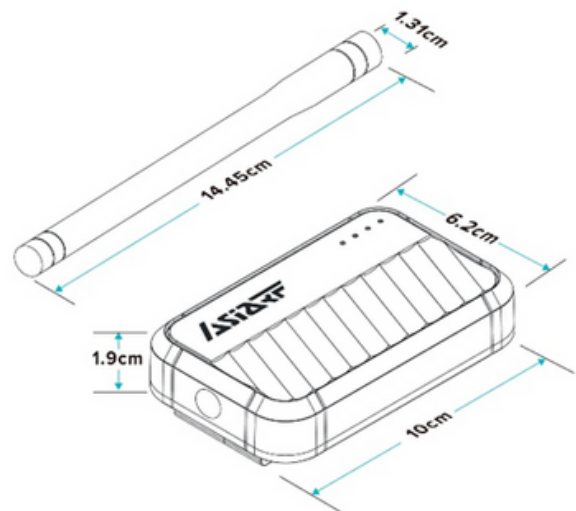

Frequency

Wi-Fi 4: 2412MHz-2462Mhz
Wi-Fi HaLow:923MHz-927MHz

Certification Status

certified in Taiwan

Expected Testing Date

2024 05

AsiaRF Co., Ltd.

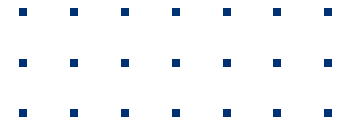

AsiaRF, founded in Taipei in 1997, is a global leader in wireless connectivity solutions, trusted especially in North America. We offer Wi-Fi HaLow™, Wi-Fi 7, Wi-Fi 6E, Wi-Fi 6, 5G, BLE, LoRa WAN, and more. Committed to quality and service, we collaborate with Taiwanese distributors to stay competitive.



**Wi-Fi HaLow Mesh
Outdoor Gateway
ARFHL-OD**

ARFHL-OD Outdoor Gateway is designed to fulfill field long distance 20 Mbps data requirements by Wi-Fi HaLow technology. Wi-Fi HaLow Morse Micro MM6108 chipset, Powered by PoE(802.3af)



Frequency

Wi-Fi 4: 2412MHz-2462MHz
Wi-Fi HaLow:923MHz-927MHz

Certification Status

certified in Taiwan

Expected Testing Date

2024 06

ASKEY Computer Corp.

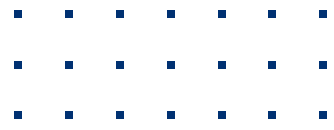

Established in 1989, Askey Computer Corp. is a member of ASUSTeK Computer Inc., specializing in development of network communications and electronics manufacturing. With nearly 6,000 staff, Askey is headquartered in New Taipei City, Taiwan. Equipped with advanced manufacturing sites both at domestic and abroad. Askey now has R&D and business strongholds in Taiwan, China, Brazil, Japan, America and more.



RTM4100AH

RTM4100AH includes 3 wireless technologies, 802.11n (Wi-Fi 4), 802.11ah (Wi-Fi HaLow) and Bluetooth (BT5.1) and support USB LTE dongle also. Askey also can provide management system to record and analysis collected data from devices.

The key features:

- 802.11b/g/n + 802.11ah + BT5.1
- Support USB LTE dongle
- 1Gb WAN and 1Gb LAN
- AP/Station mode
- 802.11s mesh
- IP55 rating



Frequency

Wi-Fi
 US 2.4GHz (2412MHz ~ 2472MHz)
 JP 2.4GHz (2412MHz~2462MHz)

11ah
 US 902~928MHz
 JP 921-927MHz

Certification Status

certified in Japan

Expected Testing Date

2024 07

ASKEY Computer Corp.

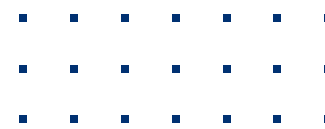

RTM4100AH



Scenarios

RTM4100AH can deliver environment parameter by Bluetooth sensor, 1080p video by Wi-Fi Halow camera in long distance and periodical data collection environment as farm, factory, street or rural area. It helps to save human resource and sends notification from cloud system if triggered by rules.

Cases

RTM4100AH can be used in smart bus stop/station to deliver live bus status. Government can save much money if we change communication components from LTE module to RTM4100AH.



CONTEC CO.,LTD.

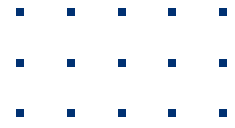

Found In 1975, Contec Corporation, has been contributing to society as a world pioneer by providing various input/output (I/O) boards, industrial PCs (Box-PC, Panel-PC, Rack-PC, etc.), wired and wireless LAN, industrial LCD displays, various related support software and BTO Solution, with "PC For All Automation" as the cornerstone of business.

RP-WAH-SR1
RP-WAH-SR2



Compact IEEE802.11ah-compliant wireless LAN converter, compliant with the IEEE802.11ah standard, enabling the construction of high-speed and long-distance wireless networks. It supports external antennas, allowing for flexible construction of wireless LAN systems, and its lightweight and compact design enables installation on walls, DIN rails, and various other locations with the included mounting bracket. It can also be used as an access point (parent station) that can connect up to four stations (child stations) by switching modes.



Frequency

920MHz

Certification Status

certified in Japan, TELEC

Expected Testing Date

NA

CONTEC CO.,LTD.

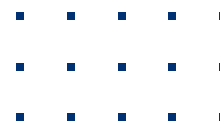

RP-WAH-SR1
RP-WAH-SR2



Scenarios

1. Wireless connection of outdoor surveillance camera images for systems using surveillance cameras.
2. Wireless communication of information (remote I/O) from sensors at remote locations.
3. wireless communication of information from PLCs in remote locations within the factory premises. (This means monitoring equipment information in places where wireless LAN cannot reach.)

Cases

- Wireless image transmission in a system using surveillance cameras.
- Input/output of information from sensors in remote locations using remote I/O.
- Collect information from PLCs in remote locations within a factory using a wireless network.

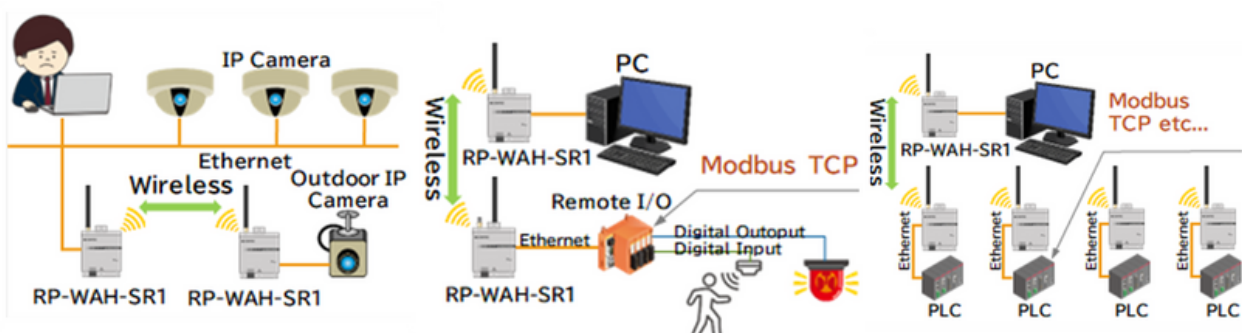

sales@jp.contec.com



<https://www.contec.com/jp>

D-Link

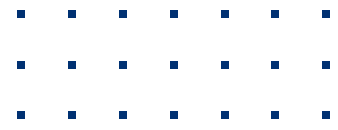

D-Link



D-Link is a global leader in designing and developing networking and connectivity products and total solutions for consumers, small businesses, medium to large-sized enterprises, and service providers. From relatively modest beginnings in Taiwan, the company has grown into an award-winning global brand in 43 countries.



MS30N

D-Link's MS30N is a Matter-certified IoT gateway to connect Matter-compliant network devices and can also perform as a router, access point, or extender. As the heart of the smart home or any IoT application, the MS30N utilizes Wi-Fi 6, Thread, Bluetooth, and Wi-Fi HaLow™ technologies to deliver secure and reliable connections for all connected devices.



Frequency

Wi-Fi, Thread,
Bluetooth LE,
Wi-Fi HaLow protocols

Certification Status

certified in Japan

Expected Testing Date

2024 05

D-Link

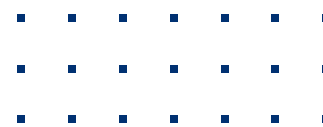

D-Link

MS30N



Scenarios

D-Link Smart Healthcare is an all-in-one caregiving solution combining networked devices, CMS, and app to remotely monitor the daily lives of elderly people. This is done by installing MS30N IoT gateways, sensors, cameras, and smart plugs in their homes. The MS30N performs as the central hub for the home's wireless connection with capabilities such as prioritizing bandwidth for video viewing, event sensing, and power usage monitoring via the CMS and app. This solution provides non-stop elderly monitoring, saving time and manpower for families or medical institutions in the era of caregiving personnel shortage.

Cases

This turnkey solution integrates management software and IoT hardware devices as an Elderly Monitoring System, including IoT-based fall detection, home energy consumption monitoring to improve elderly in-home safety, and AI privacy guard. The MS30N connects wireless cameras, sensors, and smart plugs via Wi-Fi, Wi-Fi HaLow™, and Thread protocols to assist caregivers and family members to efficiently monitor elderly's daily lives.

This solution enables any ISP or SI to increase operational efficiency, reduce complexity, and enhance care quality for the elderly.



sales@dlinkcorp.com



www.dlink.com

Edgecore

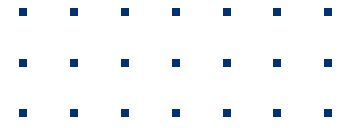

Edgecore Networks is a wholly owned subsidiary of Accton Technology Corporation. Edgecore delivers network solutions through channel partners worldwide that keep information moving and connections strong for SMB, enterprise, data center, and service provider customers.

EAP112



EAP112 stands out as an enterprise-grade IoT Gateway, incorporating Wi-Fi 6, HaLow, BLE, Zigbee, Thread, and LTE technologies to drive advanced AI solutions. EAP112 supports Wi-Fi 6 2x2 uplink and downlink MU-MIMO, delivering an impressive up to 3 Gbps data rate within its IP65-rated enclosure. With Bluetooth Low Energy (BLE) radio, ZigBee, Thread, and HaLow capabilities, EAP112 facilitates the implementation of value-added applications like iBeacon and Matter, fostering seamless communication among diverse IoT devices. The inclusion of Wi-Fi HaLow addresses the need for long-range, low-rate data transmission, while the additional LTE interface serves as an alternative uplink connection to the internet. EAP112 offers the flexibility to operate in standalone mode or under the management of Edgecore ecCLOUD or the ecCLOUD-VPC controller.



Frequency

902-928 MHz
(country dependent)

Certification Status

certified in Japan

Expected Testing Date

2024 05

Edgecore

Edge-core
NETWORKS

EAP112

Scenarios

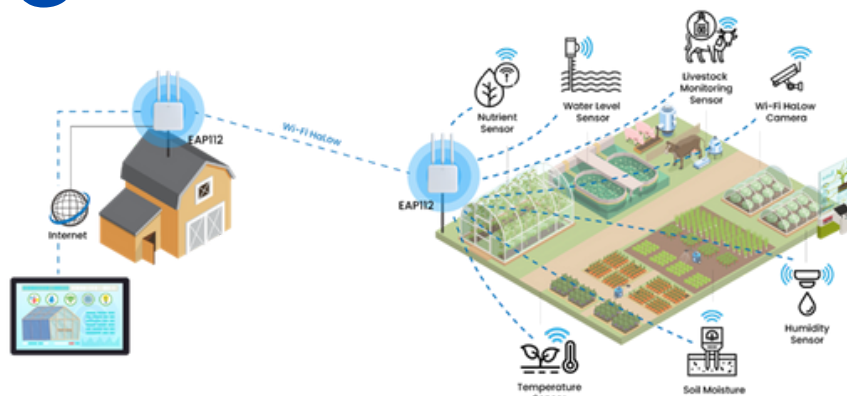

The Edgecore Wi-Fi EAP112 is a groundbreaking six-technology integrated wireless IoT solution that supports Wi-Fi 6, Wi-Fi HaLow, BLE, Zigbee, Matter, LTE, CBRS, and Ethernet protocols, this innovative device caters to both short- and long-range communication needs. Designed to withstand extreme temperatures and environmental conditions, boasting IP65 water and dust resistance, making it suitable for diverse environments and industries such as Smart Agriculture for monitoring and managing vast farmlands through sensors, cameras, and unmanned vehicles; Industrial IoT for enhancing manufacturing processes and site management; Telecommunications for providing LTE and CBRS connectivity to end-users in remote areas; Smart Cities for building intelligent urban infrastructure like traffic monitoring and public safety networks; Healthcare for supporting medical IoT devices and patient monitoring. By offering comprehensive software integration and native MQTT support, the EAP112 simplifies IoT deployment, providing a versatile platform that bridges multiple communication protocols, unlocking innovative connectivity possibilities, and solving network challenges in diverse environments.

Cases

The Smart farm is implementing smart agriculture technologies to enhance the production. The initiative addresses challenges like dispersed gardens and inconsistent crops quality through digital tools, remote sensing, and AI analysis. Since there is a distance between the farmhouse and the farm and they cannot be connected via wired networks, HaLow enables longer-distance transmission. IoT devices on the farm, such as soil monitoring, temperature and humidity, water quality monitoring, automatic watering, health monitoring by sensors, and farm status monitor by CCTV, can transmit information back to the farmhouse through HaLow. This allows the farm owner to monitor farm conditions in real time, improving crop quality and increasing work efficiency. By using smart IoT devices, the owner has reduced work hours by 25%, standardized crops quality, and increased the sales by 10%.



tt_hsu@accton.com



wifi.edge-core.com

Furuno Systems Co., Ltd.

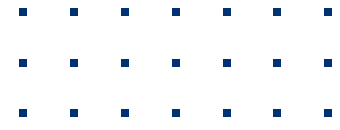

FURUNO SYSTEMS



Established in 1984, Furuno Systems is a dedicated manufacturer of wireless equipment for business use. Successfully developing Japan's first wireless handy terminal, in-house development and manufacturing of access points have been provided to enable stable communications. We are committed to supporting the telecommunications that are indispensable to everyone's daily life with the wireless technology that we have cultivated over the years.



ACERA 330

ACERA 330 is a Wi-Fi HaLow-compliant access point that also supports 2.4GHz band 11n/b/g, BLE, and USB to accommodate IoT devices with a variety of interfaces and enable data transmission to remote locations via Wi-Fi HaLow. Configurable to switch between access point, repeater, and station modes. Operating temperature is -20 to 60°C, and dust and water resistance is IP55.



Frequency

921-927MHz

Certification Status

certified in Japan

Expected Testing Date

NA

Furuno Systems Co., Ltd.

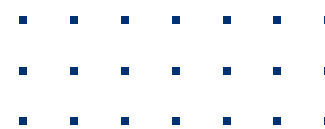

FURUNO SYSTEMS

ACERA 330



Scenarios

In cases where a person is regularly patrolling the area to monitor the situation, or where the situation is being checked by a sensor but the person wants to monitor the situation with video, the ACERA 330, camera, and sensor can be combined to enable remote monitoring without the need to go to the site. Examples of ACERA 330 applications are as follows:

- Flood monitoring of rivers and roads using cameras
- Crop growth monitoring using sensors and cameras
- Security camera applications in schools and neighborhoods.

Cases

ACERA 330 has been adopted for a demonstration experiment to remotely monitor greenhouses using temperature/humidity sensors and cameras. The ACERA 330 parent unit was installed at a facility operated by the city and connected to an Internet line, and ACERA 330 child units were installed at six greenhouses several hundred meters (maximum 900 m) away from the parent unit, each connected in a star configuration to create a network. The system enables farmers to monitor the status of their greenhouses from their homes via the Internet, and is expected to contribute to more efficient agriculture.



Silex technology, Inc.

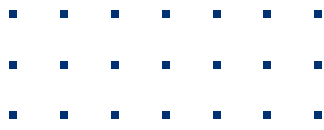

Through wireless expertise, unrivaled quality, and dedicated support, Silex Technology delivers highly reliable and secure wireless connectivity products for medical, industrial, and commercial customers. We are dedicated to providing a single-vendor solution for hardware and software support from design through manufacturing, which results in a completely connected, always-on experience.

AP-100AH(JP)



AP-100AH is the first commercially available access point supporting IEEE's 802.11ah wireless standard which is a long-range technology where a single access point can give you range up to 1 kilometers supporting up to 675 clients. The AP-100AH is all that you need to incorporate 802.11ah into your existing or new infrastructure. The AP-100AH supports communication with a RADIUS server to enable 802.11ah client devices which are capable of 802.1X authentication.



Frequency

920.5-928.1MHz

Certification Status

certified in Japan

Expected Testing Date

NA

Silex technology, Inc.

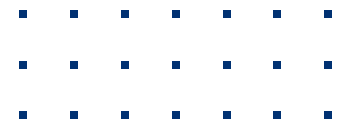

Through wireless expertise, unrivaled quality, and dedicated support, Silex Technology delivers highly reliable and secure wireless connectivity products for medical, industrial, and commercial customers. We are dedicated to providing a single-vendor solution for hardware and software support from design through manufacturing, which results in a completely connected, always-on experience.

BR-100AH(JP)



BR-100AH is the first commercially available IEEE's 802.11ah wireless enterprise bridge. It enables any Ethernet device to communicate with other 802.11ah devices over a long-range Wi-Fi HaLow network, giving you the freedom to place it anywhere in your facility. BR-100AH is all that you need to incorporate your device into your 802.11ah (HaLow) network. The BR-100AH now supports WPA3-Enterprise to make Wi-Fi HaLow technology available for enterprises that require 802.1X authentication for its IT system.



Frequency

920.5-928.1MHz

Certification Status

certified in Japan

Expected Testing Date

NA

Silex technology, Inc.

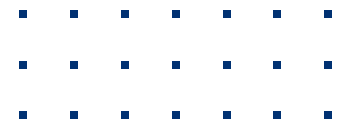

Through wireless expertise, unrivaled quality, and dedicated support, Silex Technology delivers highly reliable and secure wireless connectivity products for medical, industrial, and commercial customers. We are dedicated to providing a single-vendor solution for hardware and software support from design through manufacturing, which results in a completely connected, always-on experience.

EX-150AH(JP)



The EX-150AH is the Wi-Fi range extender enabled by Wi-Fi HaLow. You can use the EX-150AH as your Wi-Fi access point and the data from your Wi-Fi device is sent farther through the Wi-Fi HaLow link. With the combination with Wi-Fi HaLow access point, you can easily extend the wireless coverage for your Wi-Fi device. The EX-150AH has the USB Type-C as the power supply port so that it can be powered from other USB devices such as a laptop, Android tablet or a battery pack for example.



Frequency

920.5-928.1MHz

Certification Status

certified in Japan

Expected Testing Date

NA

Silex technology, Inc.

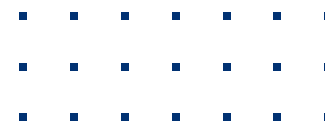

AP-100AH(JP)



Scenarios

Wi-Fi HaLow products are suitable for use in industrial and medical applications. Their long range and low power consumption enables the connectivity of a wide range of devices. In the industrial field, sensors on factory equipment and AGVs can be connected wirelessly for real-time data collection and monitoring. This enables efficient production control and equipment maintenance. In the medical field, patient monitoring devices and hospital medical equipment can be connected securely and reliably, enabling medical professionals to instantly monitor equipment and patient status.

Cases

Data collection through ModbusTCP system in medical laboratories

- AP-100AH integration into the network and BR-100AH to connect ModbusTCP PLC to the AP-100AH.

Infrastructure extension to eliminate Wi-Fi deadspot in factories/plants

- AP-100AH to create Wi-Fi HaLow LAN. The BR-100AH connected to Wi-Fi access point to let Wi-Fi devices to join the HaLow network.

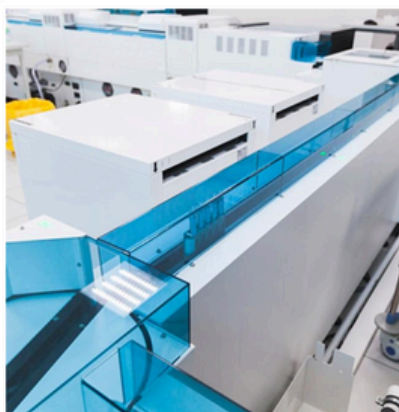

<https://www.silex.jp/contact/>



<https://www.silex.jp>

Vantron Technology Inc.

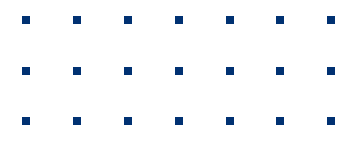

Vantron



For over twenty years, Vantron Technology has been a leading global provider of embedded computing and intelligent IoT solutions. With our commitment to continuous technology innovation and customer-centric engagement model, Vantron strives to provide state-of-the-art and highly cost-effective turn-key solutions to enable our customer's success.



HAP101-JP

- 1xWiFi HaLow 802.11ah (USA or Japan version), Based on Morse Micro MM6108.
- 1xExternal or inner Antenna
- 1xWiFi 802.11/b/g/n,
- 1xETH,
- 1xRS485/5Vout,
- 12/24VDC (9-36V) Power input.
- Inner antenna.



Frequency

High

Certification Status

certified in FCC, TELEC in progress

Expected Testing Date

2024 05

Vantron Technology Inc.

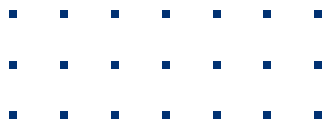

Vantron



HAP101-JP

Scenarios

This HaLow AP is work at long distance data connection up to 1Km based on WiFi HaLow in sub 1GHz frequency. And up link can be standard WiFi or Ethernet network to internet.

It can work as WiFi HaLow Station, and connect to another HaLow AP to extend network connection by Standard WiFi or Ethernet network.

Bridge WiFi AH to WiFi4, or WiFi AH to ETH.

Cases

Home security, Access control, Video Phone, Wireless Sensor network, etc.

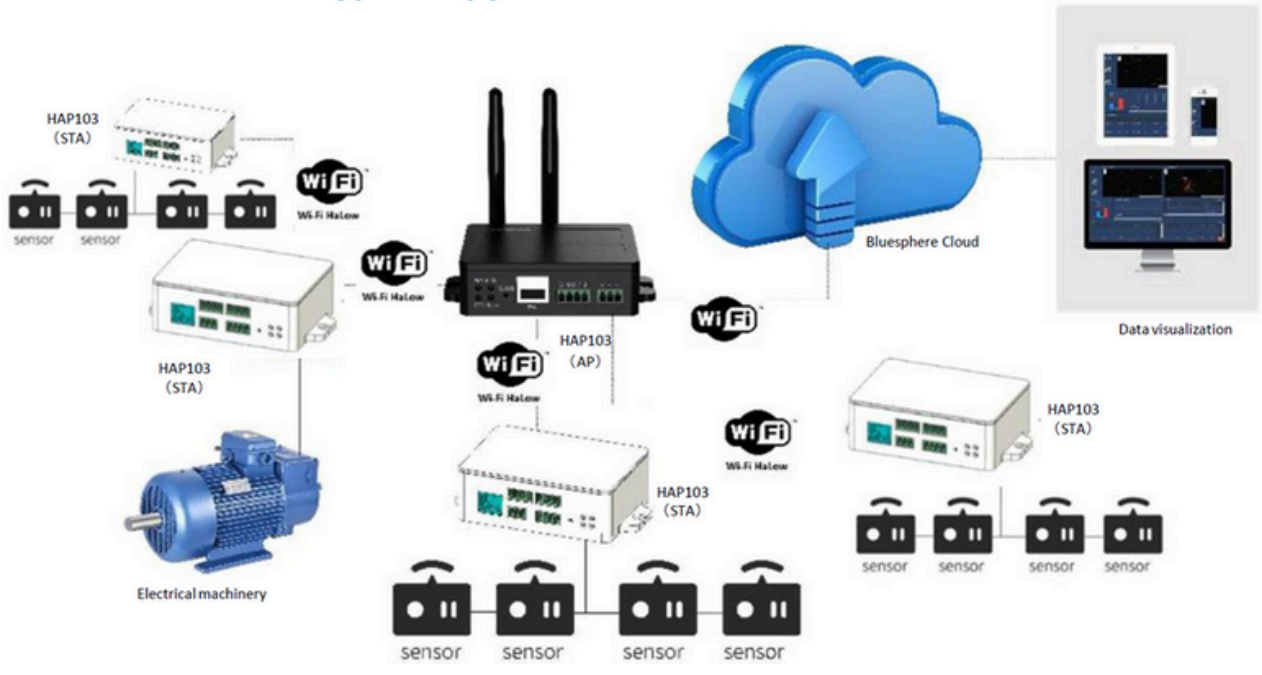

Vantron Technology Inc.

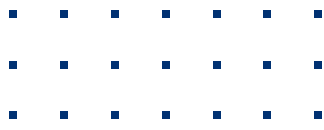

Vantron



For over twenty years, Vantron Technology has been a leading global provider of embedded computing and intelligent IoT solutions. With our commitment to continuous technology innovation and customer-centric engagement model, Vantron strives to provide state-of-the-art and highly cost-effective turn-key solutions to enable our customer’s success.



HC081

- WiFi HaLow 802.11 ah (USA or Japan version), Based on Morse Micro MM6108.
- 1x5MP Camera,
- 1x1W Speaker,
- 1xMIC Input,
- 1xUSB-C, with 5V Power input,
- 1xCall ON/OFF button,
- 1xRestore button,
- 1xInner with 2000mAh Li-Battery.
- 1xTripod mounting hole
- 1xMicro-SD Card Slot.



Frequency

High

Certification Status

certified in FCC, TELEC in progress

Expected Testing Date

2024 06

Vantron Technology Inc.

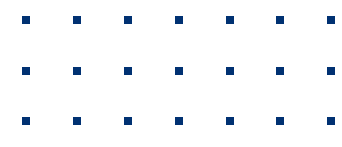

Vantron



HC081

Scenarios

This HaLow AP is work at long distance camera video capture and streaming up to 200m+ based on WiFi HaLow in sub 1GHz frequency.

It will work with HaLow AP to transfer video to center network tablet / device, and provide audio communication between camera and center network tablet / device/

Cases

Long Distance Communication Home security, Video Phone, etc.

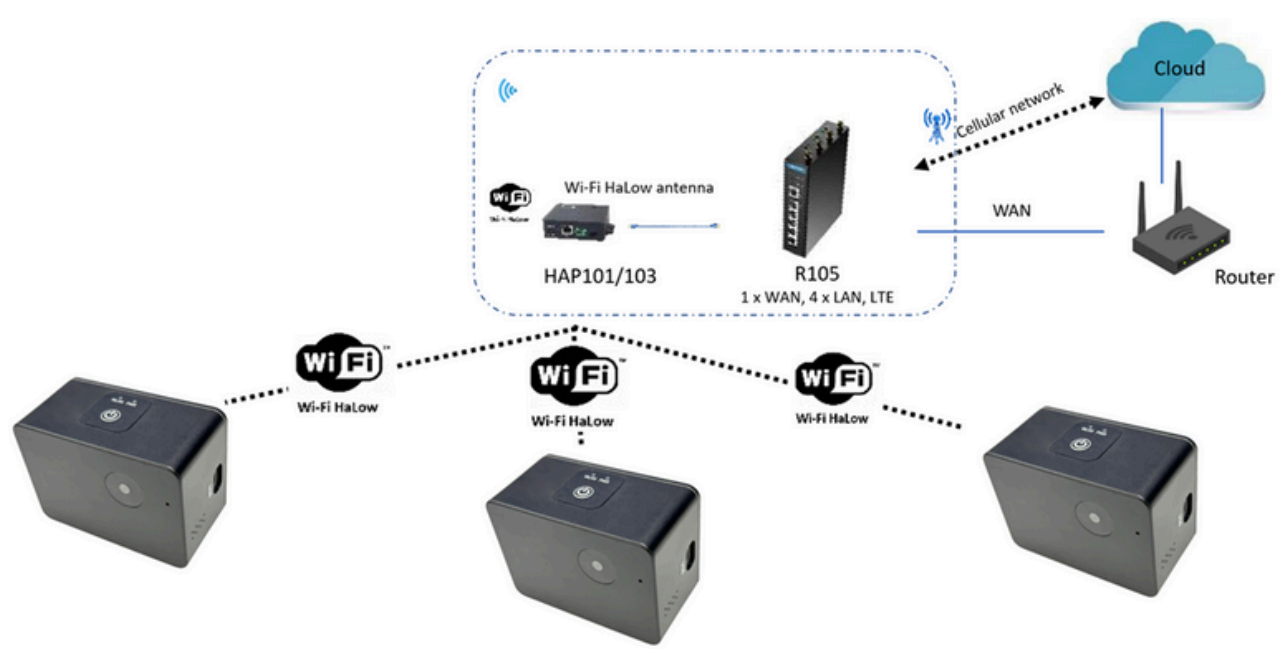

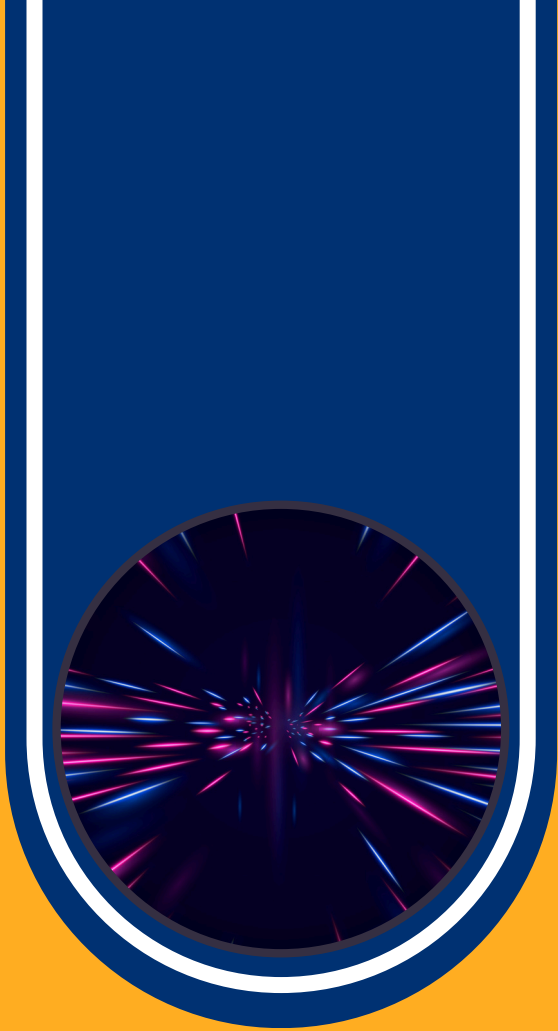

HYPHER DEVICES

TECHWARE Technology Co. Ltd.

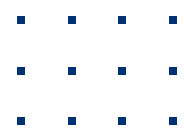

TECHWARE, with over two decades of expertise, is a leading system integrator specializing in Industrial Embedded Solutions. We excel in leveraging ARM series processors and LPWAN applications to deliver cutting-edge, user-friendly, and high-performance solutions at an affordable cost. Our dedicated focus lies in empowering users to develop reliable and cost-effective embedded products across various sectors, including industrial automation, healthcare, agriculture, and beyond. From industrial embedded gateways to HMIs, POS systems, kiosks, gaming devices, medical equipment, and intelligent agricultural solutions, we offer comprehensive system-level solutions tailored to meet the evolving needs of our clients.



SBC700Halow

Introducing the TECHWARE SBC700Halow - a compact, high-performance, and cost-effective industrial communication gateway designed to streamline data transmission between sensors/devices and servers/clouds. Featuring an impressive array of communication interfaces including 802.11ah Wifi Halow, 2.4Ghz Wifi, 10/100BaseT Ethernet, isolated RS485, USB, and LPWAN, it offers unparalleled connectivity options. Powered by Linux OpenWRT, users can effortlessly develop and deploy custom applications, ensuring tailored solutions for swift market entry. Moreover, its firmware upgradeability guarantees ongoing enhancement, making it an ideal choice for industries demanding flexibility and reliability.



<u>Frequency</u>	<u>Certification Status</u>	<u>Expected Testing Date</u>
902 ~ 928MHz	certified in US/JP/SG	2024 09

TECHWARE Technology Co. Ltd.



SBC700Halow



Scenarios

In frozen warehousing, precise temperature monitoring is essential for preserving the quality and safety of stored products like food, medicines, and other temperature-sensitive items. Typical applications include ensuring food safety and quality, maintaining pharmaceutical integrity, creating optimal laboratory conditions, and monitoring temperature during agricultural product transportation.

For these critical needs, TECHWARE offers the SBC700Halow combined with the TEMPHAWK temperature monitor. This solution aligns with the stringent standards of the HACCP food safety control system and utilizes WiFi Halow communication for reliable data transmission to the cloud. This ensures the accuracy and dependability of temperature monitoring. Additionally, the system includes a temperature alarm system to swiftly address any deviations from the desired temperature range, safeguarding stored goods effectively.

Cases

- Smart agriculture
- Frozen warehousing
- Freeze transportation
- Breeding and animal husbandry
- Refrigeration air conditioner

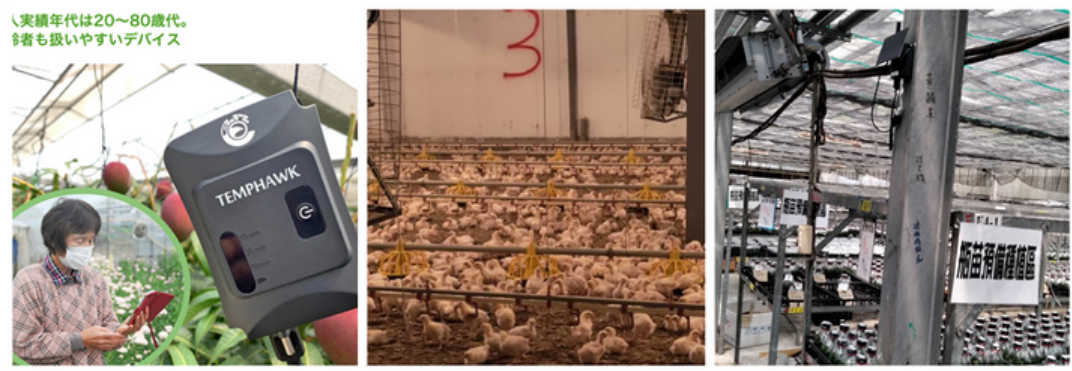

TECHWARE Technology Co. Ltd.

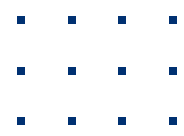

SBC700Halow



Scenarios

Introducing the Wireless Network Distance Extender, a revolutionary network device harnessing the long-distance communication capabilities of WiFi Halow 802.11ah. By utilizing a pair of SBC700Halow units, this extender effectively extends the reach of wireless network communication from mere meters to kilometers. What sets this solution apart is its seamless integration - requiring no modification to existing device settings, it enables swift and direct implementation. Experience unparalleled connectivity expansion without the hassle, unlocking new possibilities for seamless long-distance communication.

Cases

- Based on wire or wireless ethernet TCP/IP devices can apply this extender.
- Industrial Automation PLC/PAC
- Automation Robot
- Warehouse sensors
- IP Camera

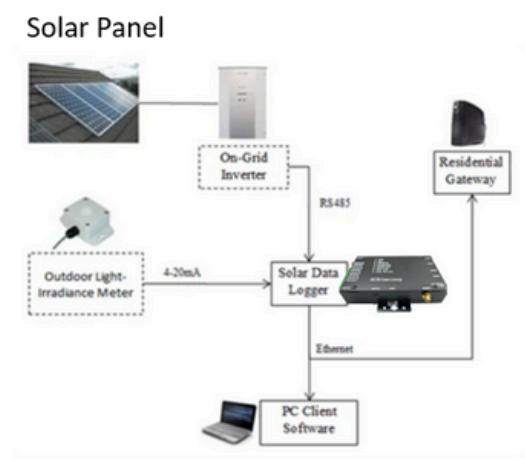

TECHWARE Technology Co. Ltd.

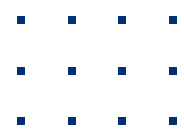

TECHWARE, with over two decades of expertise, is a leading system integrator specializing in Industrial Embedded Solutions. We excel in leveraging ARM series processors and LPWAN applications to deliver cutting-edge, user-friendly, and high-performance solutions at an affordable cost. Our dedicated focus lies in empowering users to develop reliable and cost-effective embedded products across various sectors, including industrial automation, healthcare, agriculture, and beyond. From industrial embedded gateways to HMIs, POS systems, kiosks, gaming devices, medical equipment, and intelligent agricultural solutions, we offer comprehensive system-level solutions tailored to meet the evolving needs of our clients.



HaloBlue

Introducing HaloBlue: a reliable, widely embraced sensor device with Bluetooth and long-range WiFi Halow support. Designed as a communication hub, it seamlessly collects data from local sensors and transmits it to internet cloud servers. HaloBlue offers a versatile range of I/O interfaces including I2C, SPI, ADC, PWM, Counter input, and GPIO, alongside RS485, Bluetooth 5.2, and WiFi Halow wireless communication capabilities. Powered by the Nordic nRF52840 processor and Newracom 802.11ah WiFi Halow network device, HaloBlue provides an extensive library of reference codes for rapid application development. With accessible development packages like Arduino and VS Code, creating your connected products is effortless. Plus, HaloBlue's firmware upgradeable feature ensures continuous enhancement of features and stability, ensuring your solutions stay cutting-edge.

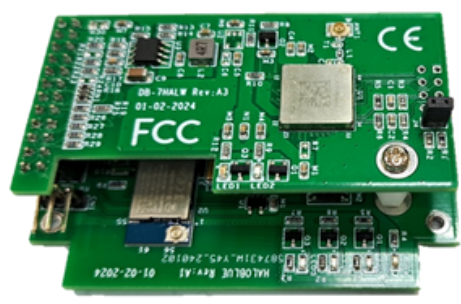

<u>Frequency</u>	<u>Certification Status</u>	<u>Expected Testing Date</u>
902 ~ 928MHz	certified in US/JP/SG	2024 09

TECHWARE Technology Co. Ltd.

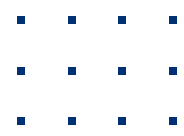

HaloBlue

Scenarios

Introducing HaloBlue: your advanced wireless data capture solution, powered by WiFi Halow and Bluetooth technology. With HaloBlue, configuration is a breeze through mobile devices, and data collection is seamless via Bluetooth connectivity. Featuring versatile sensor interfaces including I2C, SPI, PWM, and RS485, it ensures comprehensive data acquisition capabilities. Plus, leveraging WiFi Halow for long-distance wireless communication, HaloBlue efficiently transmits data to the cloud, enabling real-time access and analysis. Simplify your data capture process with HaloBlue.

Cases

- 1. Machine Learning with TinyML support
- 2. Explosion-proof Light Dimming Controller
- 3. Thermal Camera
- 4. Temperature Monitor
- 5. Weather Monitor Station

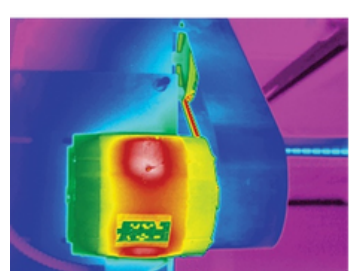
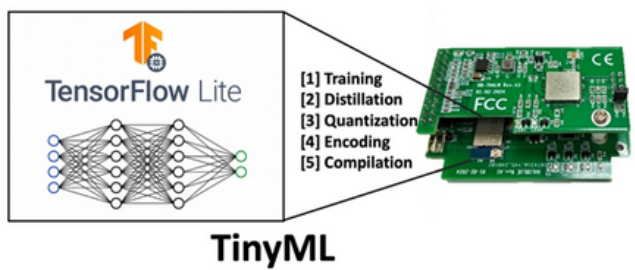

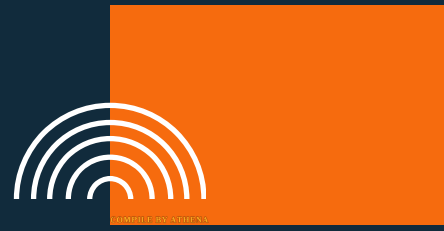

ALL COMPANY

A AcSip
ALFA
AsiaRF
ASKEY
AzureWave

N Newracom

C CONTEC

S Silex

D D-Link

T TECHWARE

E Edgecore

U UConnet

F FURUNO Systems

V Vantron
Vizmonet

M MegaChips
Morse Micro